

Cable clamp with nail plug, max. 40 cables KKS40 (OZ144)



For quick installation of cables in suspended ceilings on walls or ceilings using a concrete nailer or impact installation without the need for additional tools.

Customised installation options enable high flexibility and maximum time savings thanks to the new geometry of the mounting satellite.

Mounting option 1:

Conventional fastening with nail plug, screw (a flat-head screw 4.5x50 is recommended) or plug-in dowel

Mounting option 2:

Direct fastening with concrete nailers from brands such as Bosch, Fischer and Spit



Master data

Item number	905016
Type	OZ144 KKS 40 ND
Description 1	Cable harness KKS 40
Description 2	with nail plug 6x55 mm
Brand	DQ
Dimension	40xNYM 3x1,5mm ²
Colour	Light grey; RAL 7035
Material	Polypropylene
PU1	50
Unit of quantity	Piece
Weight	4.535 kg
Weight unit	kg/100 pc.

Dimensions

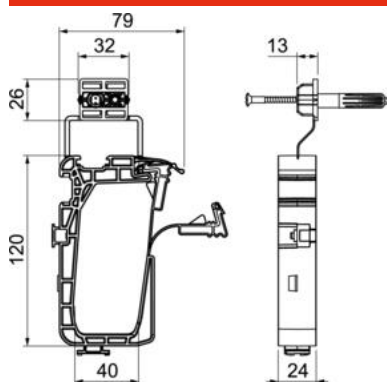

Length	67 mm
Width	24 mm
Height	120 mm

Cable clamp with nail plug, max. 40 cables KKS40 (OZ144)

Technical data	
No. of conductors NYM 3 x 1.5	40
Flame-resistant version	no
Maintain electrical functions	no
Halogen-free	yes
With anchor	yes
Suitable for direct fastening	yes